

Rectangle Counter

LN-CU-06

Dress up your space with sophisticated and functional counters. Counter tops are available in four thermoform finishes – silver, black, mahogany, and natural. Printed graphic panels create the base of the counter. Comes standard with a locking cabinet door. Custom counter top colors are available.







We are continually improving and modifying our product range and reserve the right to vary the specifications without prior notice. All dimensions and weights quoted are approximate and we accept no responsibility for variance. E&OE. See Graphic Templates for graphic bleed specifications.

features and benefits:

- Custom appearance
- Easy to assemble
- Table top available in four finishes
- Locking door
- Internal shelf
- Installation tool included
- Aluminum frame construction
- Custom top and graphic colors available
- Lifetime limited hardware warranty against manufacturer defects

dimensions:

Hardware	additional information:
<p>Assembled Unit: 25.43" w x 40.2" h x 15.1" d 1166mm(w) x 1020mm(h) x 538mm(d)</p> <p>Approximate weight: 39 lbs / 18 kgs</p>	<p>Interior Cabinet Dimensions: 22" w x 39" h x 12" d 559mm(w) x 991mm(h) x 305mm(d)</p> <p>Tabletop Dimensions: 25.43" w x 1.2" h x 15.1" d 1166mm(w) x 31mm(h) x 538mm(d)</p>
<p>Shipping</p> <p>Packing case(s): 1 OCH2</p> <p>Shipping dimensions: 52" l x 29" h x 15" d 1321mm(l) x 737mm(h) x 381mm(d)</p> <p>Approximate total shipping weight (includes case & graphics): 70 lbs / 32 kgs</p>	<p>Graphic material: UV - 6mm Sintra</p> <p>Counter holds max 50 lbs / 23 kgs</p> <p>Shelf holds max 10 lbs / 6 kgs</p> <p>When included in a larger kit, a different packaging solution will be listed to accommodate all contents of the kit. Individual packaging no longer provided.</p>
<p>Graphic</p> <p>Refer to related graphic template for more information.</p> <p>Visit exhibitors-handbook.com/graphic-templates</p>	<p>Tabletop Colors:</p> <div style="display: flex; justify-content: space-around; align-items: center;"> <div style="text-align: center;">  silver </div> <div style="text-align: center;">  black </div> <div style="text-align: center;">  mahogany </div> <div style="text-align: center;">  natural </div> </div>

Included In Your Kit

Tools, Components, Connectors, & Extrusions



5MM ALLEN-T x1

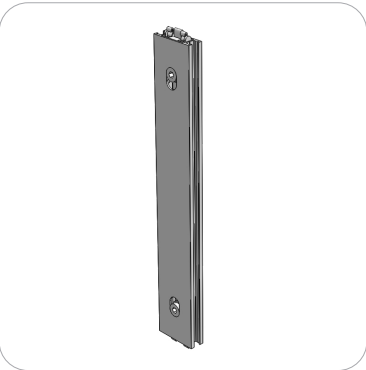

PH-280-S-S x4

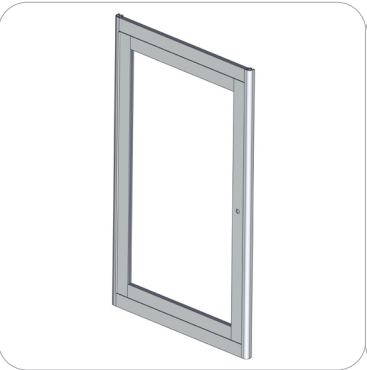

V-CAB-01-DR x1



V-CAB-01-FR x1



SS1-S x4

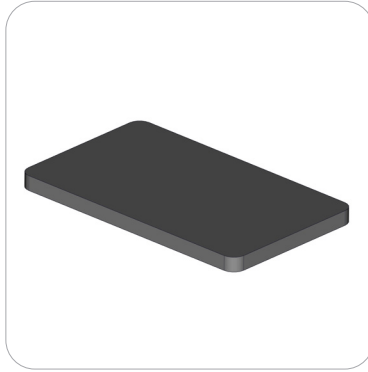

V-CW-CT-01-B x1

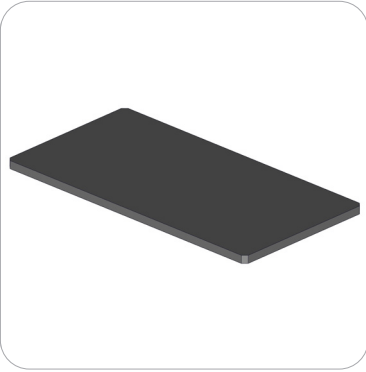

V-CU-CAB-01-S x1

Graphics

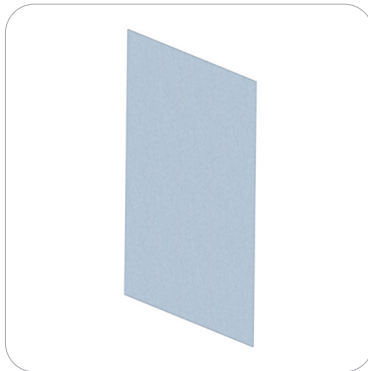

V-CAB-01-GF-FR-01 x1

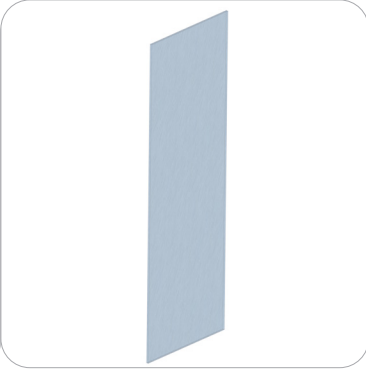

V-CAB-01-GF-SD x2

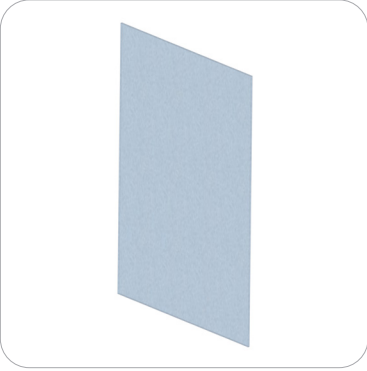

V-CAB-01-GF-DR x1

Exploded View

LN-CU-06

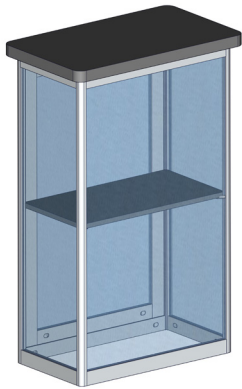

OVERVIEW

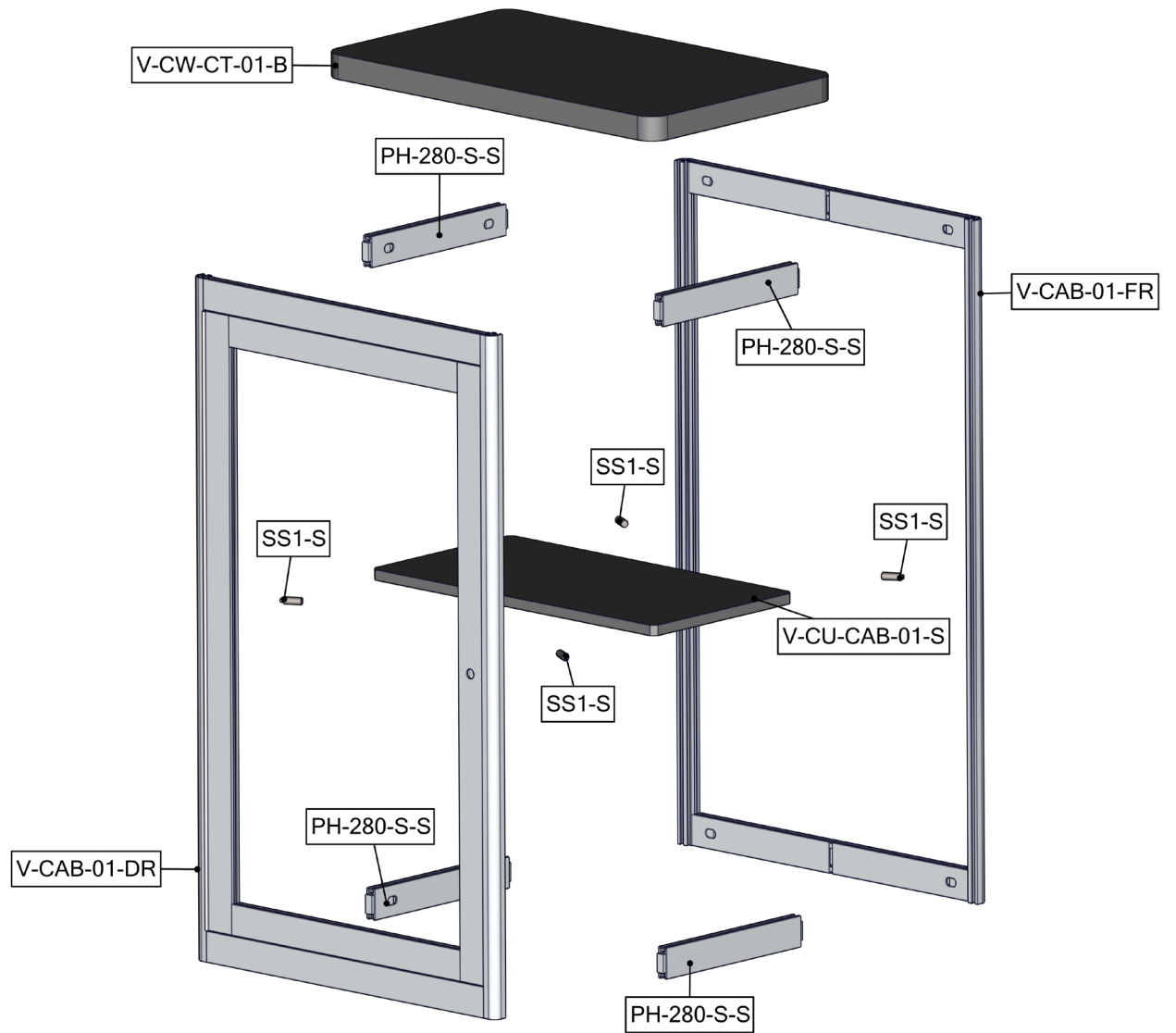
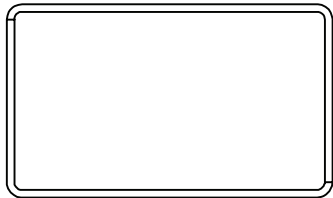

Connection Methods

Connection Method 1: P90R / PH-L

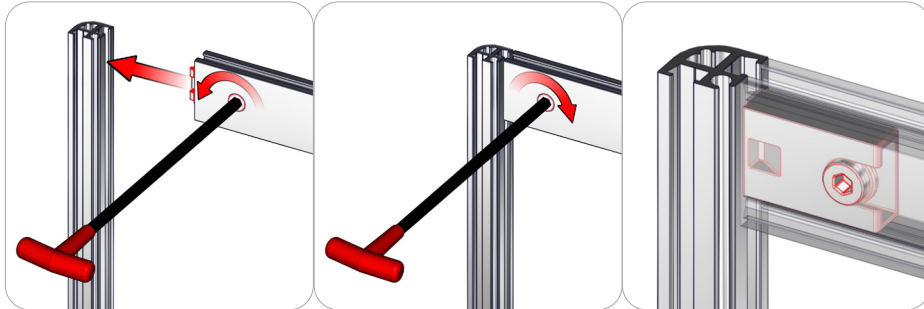

First, with the cam lock disengaged, place the cam lock teeth into the extrusion channel. Second, use the allen key tool to lock it in place. Make half turns clock-wise to engage the cam lock. Do not over tighten the lock buttons.

Connection Method 2: SS1-1

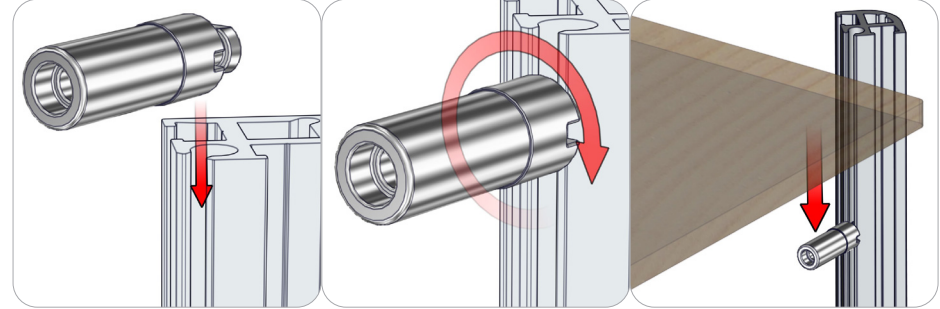

First, take the shelf support and loosen the set screw to about a 1/4 inch gap. Do not remove it. Second, slide the shelf support into the 3mm center channel. Turn the shelf support clock wise to lock it in place. Third, rest the shelf onto the shelf support. Loosen the shelf support to adjust and level.

Kit Assembly

Step by Step

Step 1.

Locate your V-CAB-01-DR and V-CAB-01-FR assemblies. Both frames should have preinstalled graphics. V-CAB-01-DR should also have a locking door, test to ensure it is properly functioning.

Reference Connection Method 1 for more details.

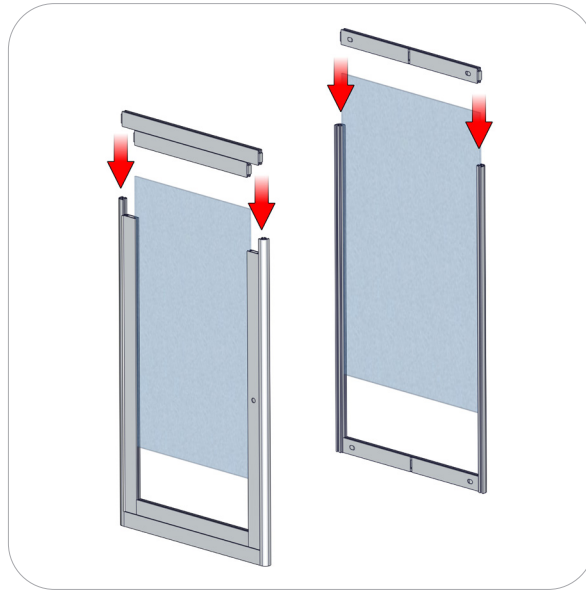

Step 2.

Locate (2) PH-280-S-S extrusions. Lock into place so that the hex bolt heads face inward to the cabinet and the extrusion is flush with the V-CAB-01-DR and V-CAB-01-FR.

Reference Connection Method 1 for more details.

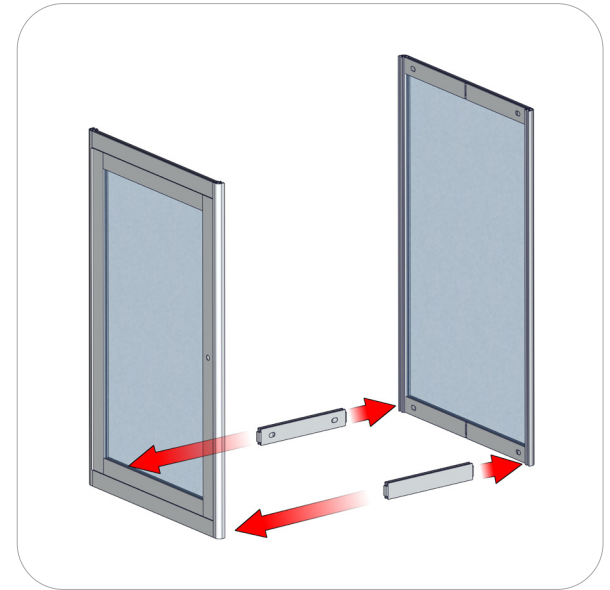
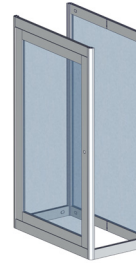

Step 3.

Locate (2) PH-280-S-S extrusions and cabinet side graphic panels. Slide your graphic into the channels of V-CAB-01-FR and V-CAB-01-DR. Next, lock your PH-280-S-S extrusions above the graphics.

Reference Connection Method 1 for more details.

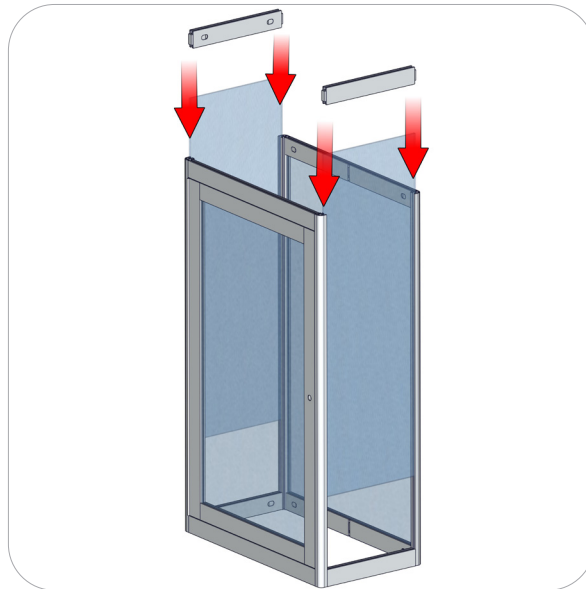
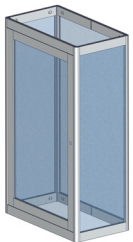

Step 4.

Locate your V-CW-CT-01-B counter top and V-CU-CAB-01-S shelf. Note the imprinted placement templates on the underside of your counter top. Attach them to the frame.

Reference Connection Method 2 for more details.

