

Metis

OR-K-MT1

Orbital Express Truss™ features over 40 professionally designed “off-the-shelf” kits for a variety of booth sizes and configurations. Each kit comes complete with all the parts, fixtures and fittings you need to create a successful exhibit, including (depending on the kit) low voltage spotlights and adjustable tabletops. A benefit to this versatile system is that it enables you to reconfigure kits in multiple ways and combinations using the same parts. Orbital Express Truss can also be easily customized!

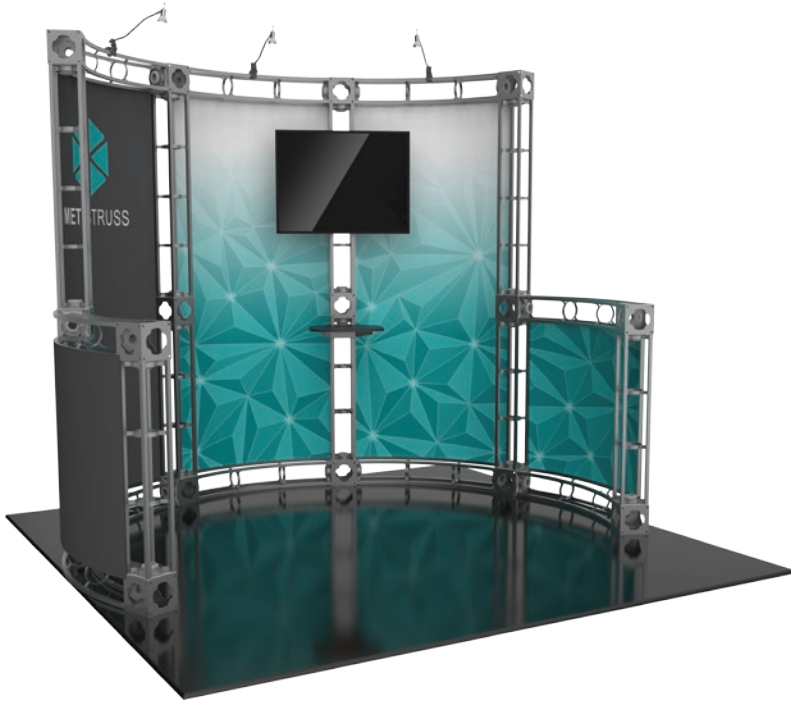

features and benefits:

- 10' x 10' kit size
- Custom appearance
- 1 adjustable tabletops
- 1 molded Case
- Simple twist and lock design
- 1 medium monitor bracket:
Holds sizes 32" - 37"
Max weight: 50lbs / 23 kg
- 5 year warranty against manufacturer defects

dimensions:

Hardware:

121.10" w x 103.25" h x 85" d
2856mm(w) x 2622mm(h) x 2159mm(d)

Graphics:

Refer to related graphic template for more information.

Visit:
www.exhibitors-handbook.com/graphic-templates

Shipping:

Packing Cases:
1 OCF2

Shipping Dimensions:
51" l x 51" w x 23" h
1295mm(l) x 1295mm(w) x 584mm(h)

Approximate weight:
332 lbs / 151 kg

additional information:

Graphic materials:
Dye sublimated or UV panels

Lumina 1, 50 watt spotlight

Tabletops (each): max weight
= 25 lbs / 11.34 kg

Tabletop color options:



silver



black



mahogany



natural

*Kit does not include monitor

We are continually improving and modifying our product range and reserve the right to vary the specifications without prior notice. All dimensions and weights quoted are approximate and we accept no responsibility for variance. E&OE. See Graphic Templates for graphic bleed specifications.

Included In Your Kit

Truss, Connectors, & Accessories

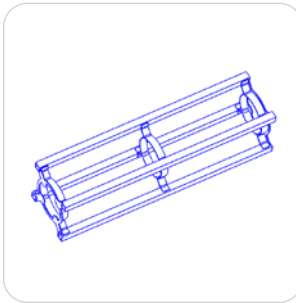

OR-24-2

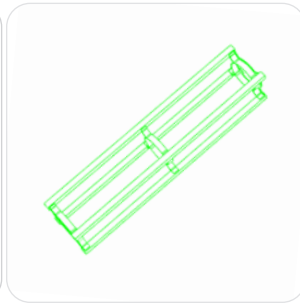

OR-30-2

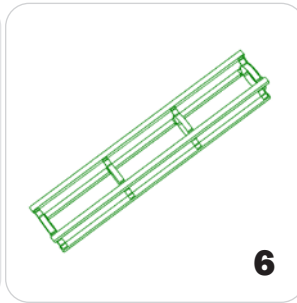

OR-36-2

6

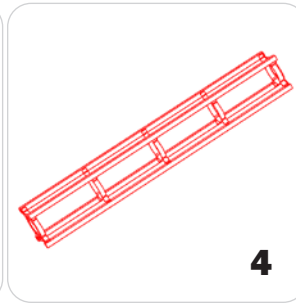

OR-46-2

4

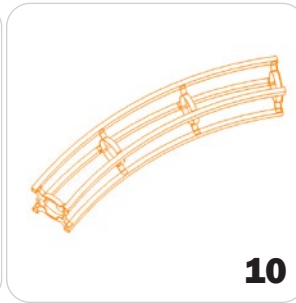

OR-45-CV-3

10

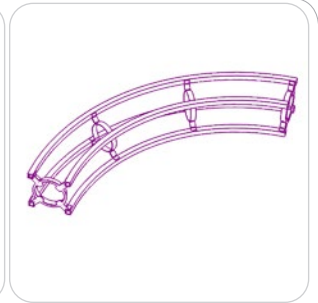

OR-90-CV-2

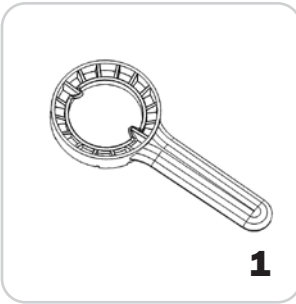

OR-TOOL-B

1

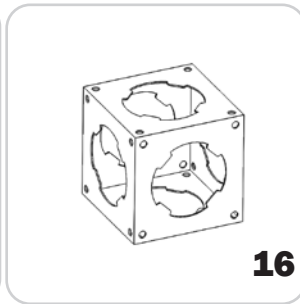

OR-J-3

16

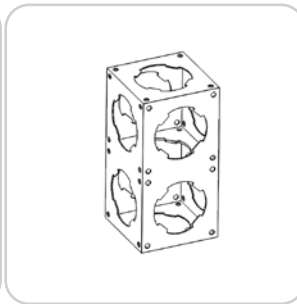

OR-J-DBL

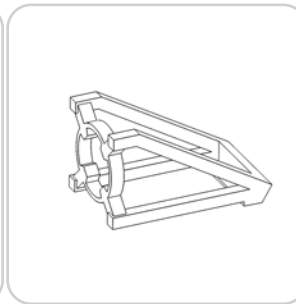

OR-B90

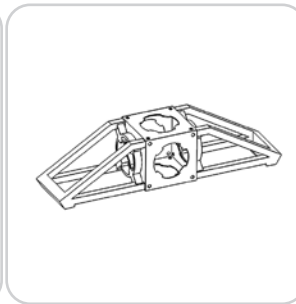

OR-B90A



OR-B45

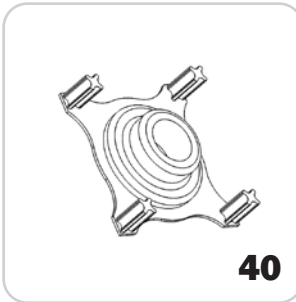

OR-QL-T2J

40

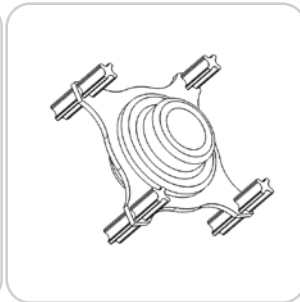

OR-QL-T2T



OR-UNC-QL

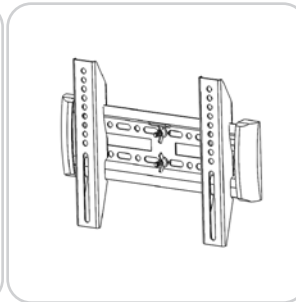

OR-SM-MB

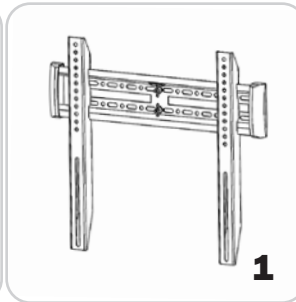

OR-M-MB

1

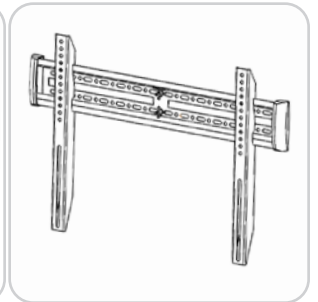

OR-LG-MB

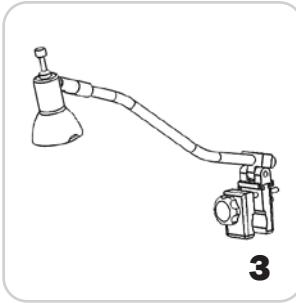

SPOTLIGHT

3

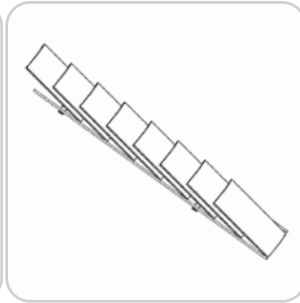

OR-STG



OR-MM-KIT

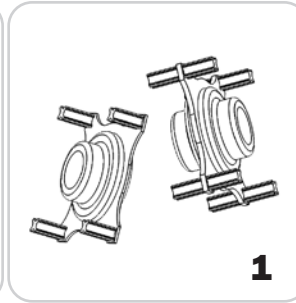

EXTRA PIECE SET

1

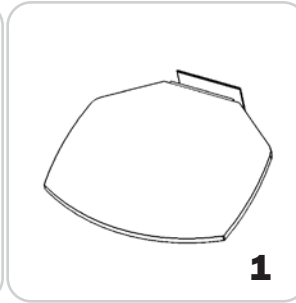





OR-TBL-B

1

Included In Your Kit

Graphics

 1	 1	 1	 1	 1
OR-G-MT1-DS / -UV	OR-G-MT2-DS / -UV	OR-G-MT3-DS / -UV	OR-G-MT4-DS / -UV	OR-G-MT5-DS / -UV

Graphics: -DS codes specify dye sublimation graphics. -UV codes specify ultra-violet graphics.

Connection Methods

Orbital Express Truss™ structures use a number of different yet simple connection methods. Your kit will include one or more of the connection methods shown below. Steps within the Kit Assembly will reference a specific method for each connection point.

Connection Method 1: Truss To Junction Box (OR-QL-T2J)

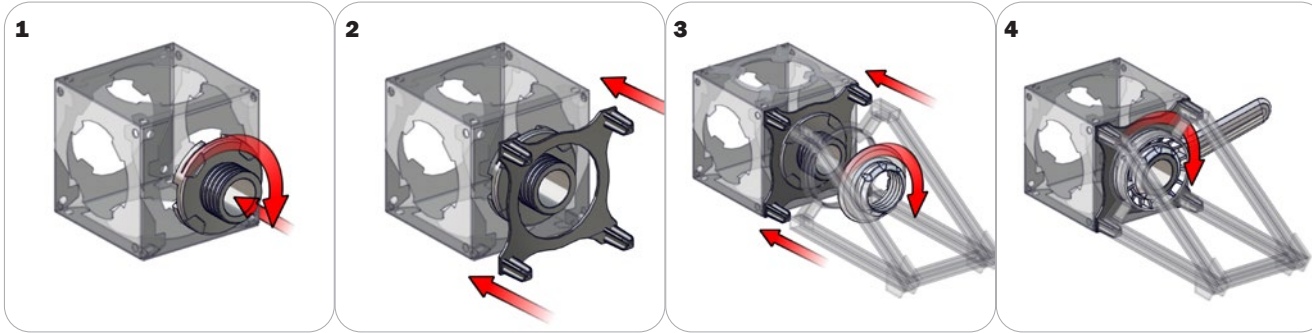

With your OR-QL-T2J (T2J) connector disassembled, insert the twist-lock hub of the connector into any large hole of the junction box and turn clockwise to lock into place (as shown in step 1). Place the bracket over the locked portion of the T2J connector so that the protruding hubs face outward (as shown in step 2). Push the truss you wish to connect onto the hubs of the T2J bracket. The hubs will slide into the holes in the end of the truss. Hand tighten the remaining cap onto the T2J connector and lock tight and securely using your OR-TOOL-B tool.

Connection Method 2: Truss To Truss (OR-QL-T2T)

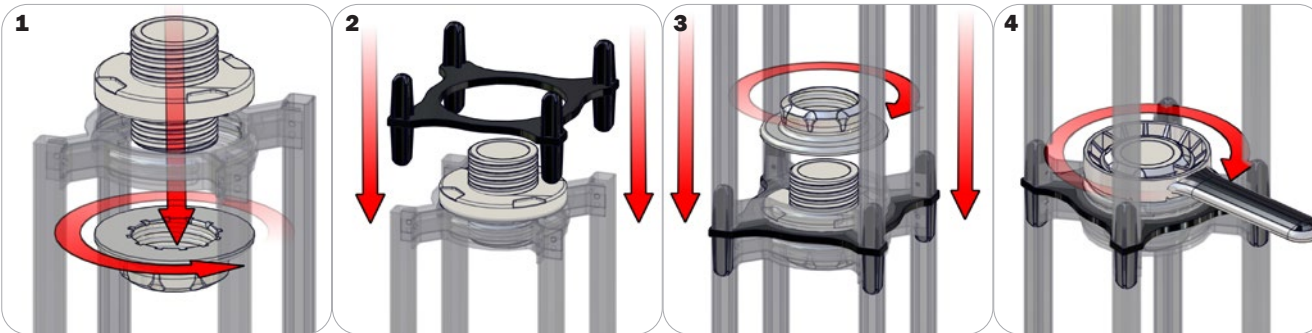

With your OR-QL-T2T (T2T) connector disassembled, assemble onto the end of your truss with the double-sided screw hub and a screw cap, then tighten with your OR-TOOL-B tool (as shown in step 1). Locate the bracket for your T2T connector. Insert the hubs of the bracket into the holes on the end of your truss. Add the truss you wish to connect by inserting the hubs of the bracket onto the second truss. Sandwich the end of the truss using the second screw cap and lock tight and securely using your OR-TOOL-B tool.

Connection Method 3: Universal Connector (OR-UNC-QL) / Accessories

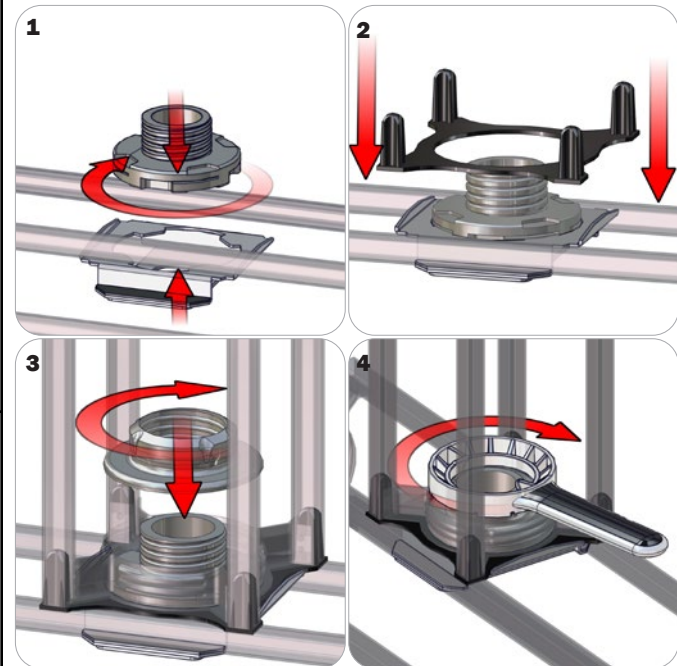

With your OR-UNC-QL (UNC) connector disassembled, assemble onto the end of the truss using the metal bracket and the screw hub. Turn clockwise to lock the bracket and twist-locking hub together. Add the plastic hub over the locked pieces so that the protruding hubs point away and the bracket sits flush. Push the truss you wish to connect onto the bracket, letting the hubs insert into the holes of the truss. Hand tighten the remaining cap onto the T2J connector and lock tight and securely using your OR-TOOL-B tool.

Exploded View

OR-K-MT1

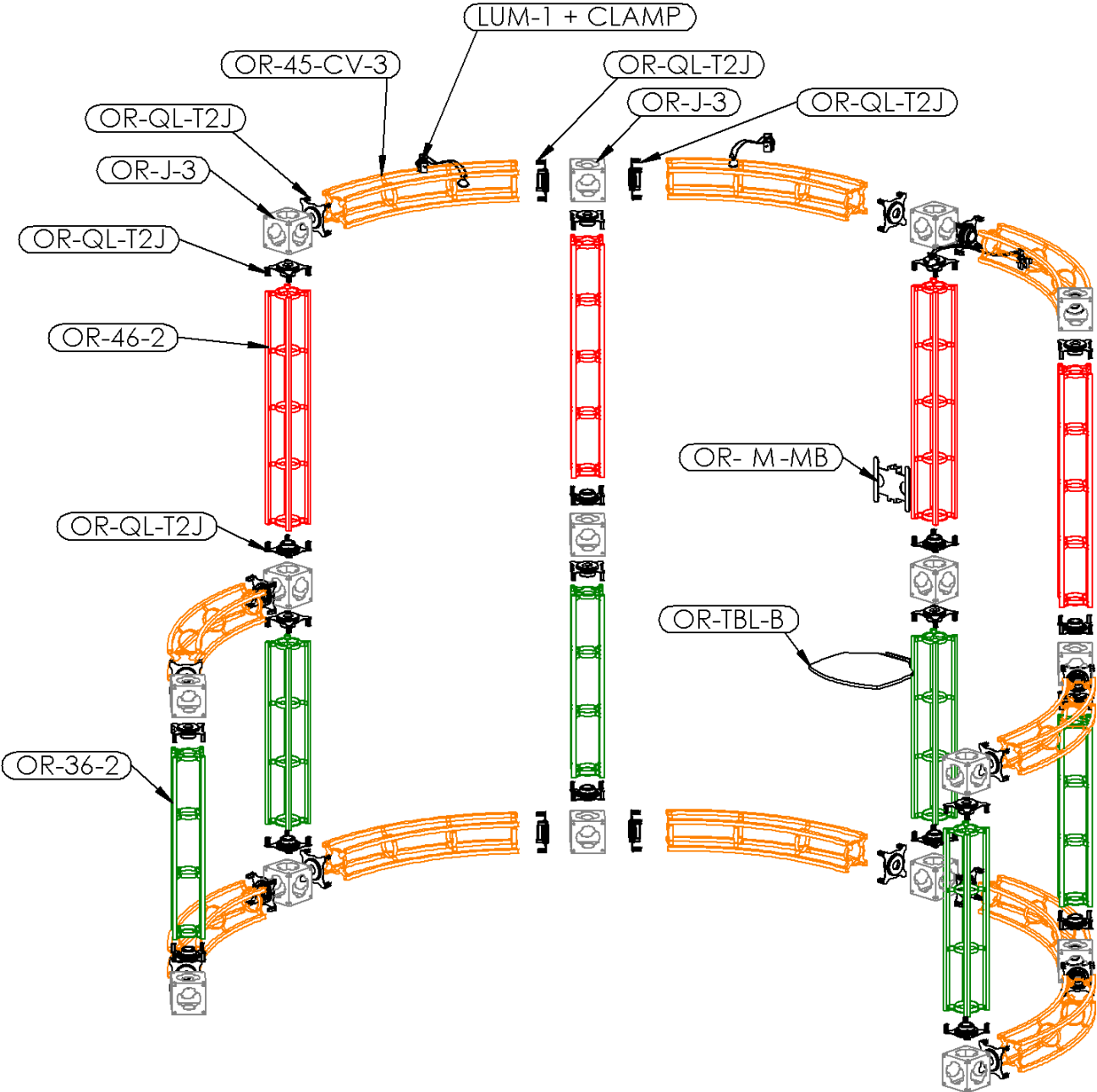

Kit Assembly

Step by Step

Step 1.

Assemble your truss kit according to the Exploded View. It is recommended to build your assembly from bottom to top.

Please reference Connection Method 1 for more details.

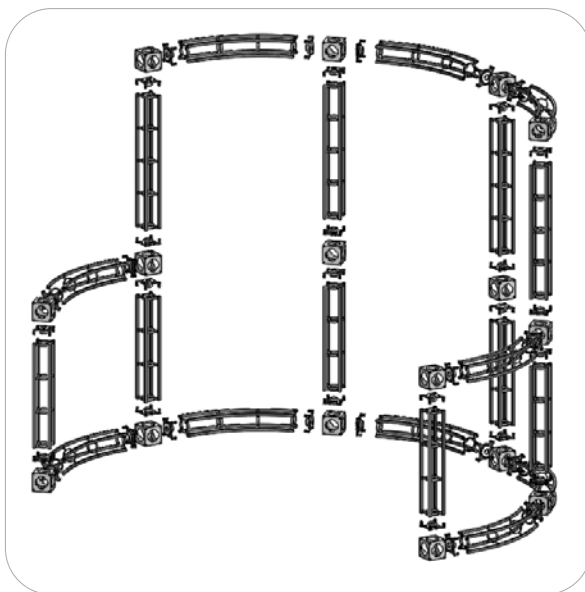
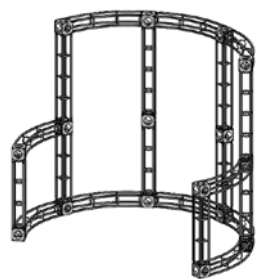

Step 2.

If your kit features "Dye Sublimation" fabric graphics, apply the hook velcro around the border of the truss you wish to apply your graphic to. Apply the graphic utilizing the pre sewn loop velcro on its unprinted side.

If your kit features "UV panel" graphics, simply attach the graphic to the truss utilizing the preapplied magnets.

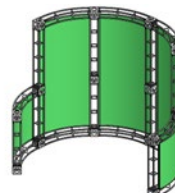

Step 3.

Slide the "Universal" clamp style light connector to your spotlights. Open your clamps using the adjustment knob. Apply the light assembly in the desired position and clamp tightly into place.

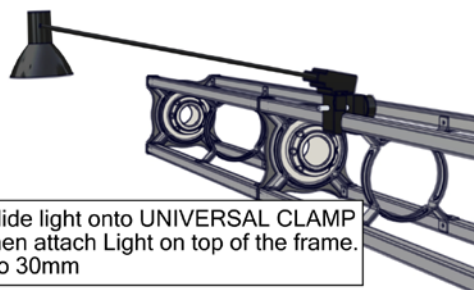
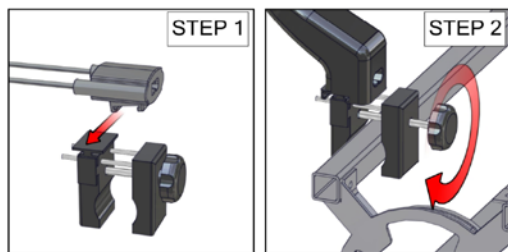
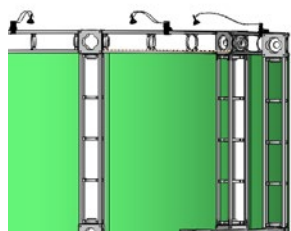

1- Slide light onto UNIVERSAL CLAMP
2-Then attach Light on top of the frame.
Up to 30mm

Step 4.

Install your OR-TBL table onto your kit. Undo the metal clamp and reassemble with truss between.

Setup complete.

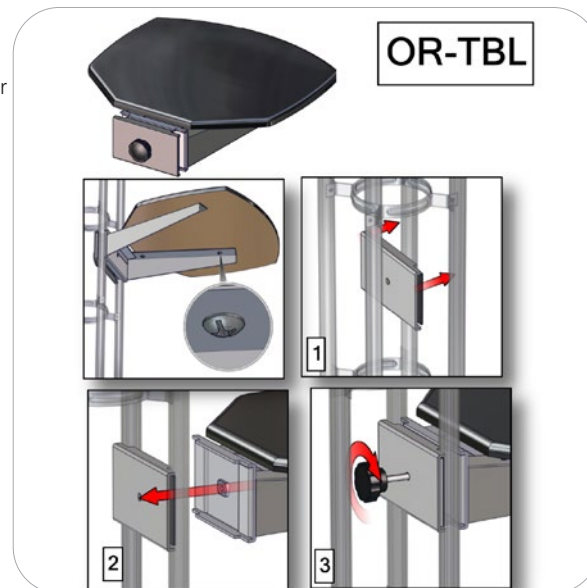
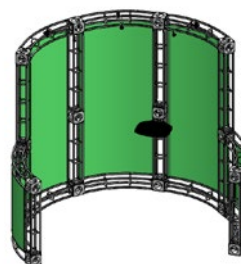

OR-TBL

Kit Assembly

Step by Step

Step 5.

Apply your monitor mounts to the truss.

Please reference the Monitor Bracket Instruction pages for more details.

Setup Complete

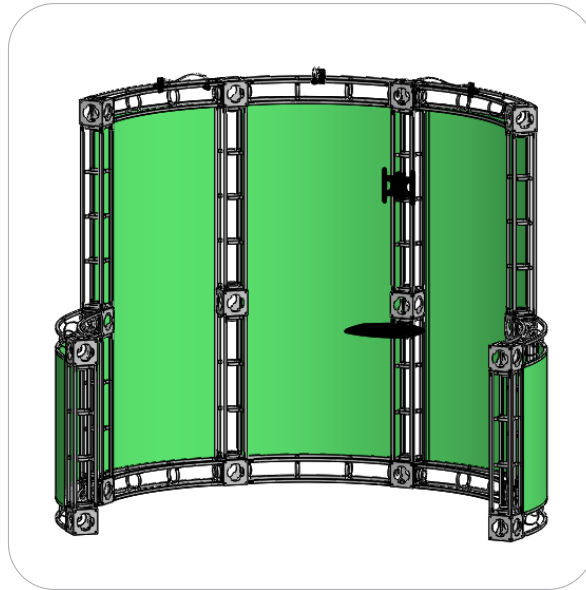

Monitor Bracket Instructions

Orbital Truss Applications



OR-SM-MB

Sizes: 17" - 37"

Max weight varies per application



OR-M-MB

Sizes: 32" - 55"

Max weight varies per application



OR-LG-MB

Sizes: 40" - 65"

Max weight varies per application

Included hardware:

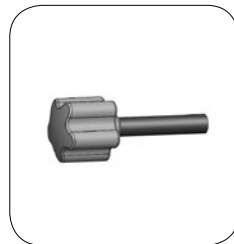

OR-IS-KNOB-2 x2

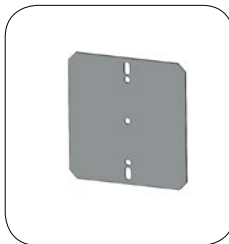

OR-TVA-PLT x1



OR-TVA-PBKT x2

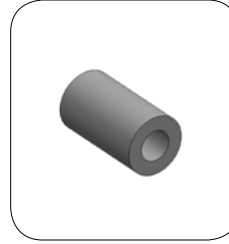

Spacer x2

ORBITAL TRUSS CONNECTION

Vertical Connection

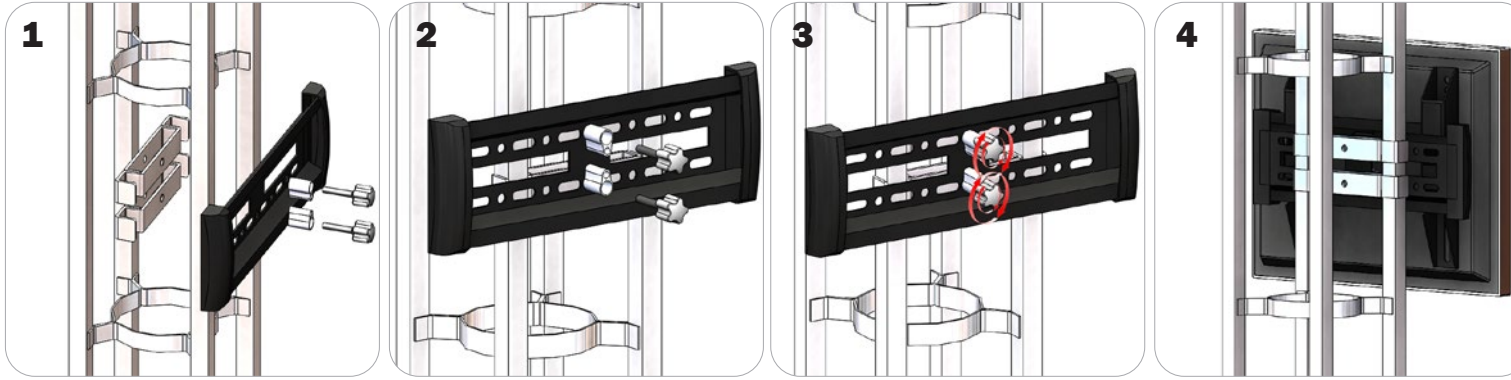

Locate all components needed to assemble the monitor mount with the Vertical Orbital Truss method. You will need (1) monitor bracket, (2) OR-TVA-PBKT-1 brackets, (2) OR-KNOB-2, and (2) spacers. Determine your desired monitor location. Place the **Step 1:** OR-TVA-PBKT-1 brackets so that they wrap around the posts of the truss. **Step 2:** Align your monitor bracket so that the center holes align with the bracket holes behind them. **Step 3:** One at a time place a spacer over the hole and thread your OR-KNOB-2 thumbscrews. **Step 4:** Reference the included manufacturer monitor mount instructions for fastening your monitor to the bracket.

Horizontal Connection

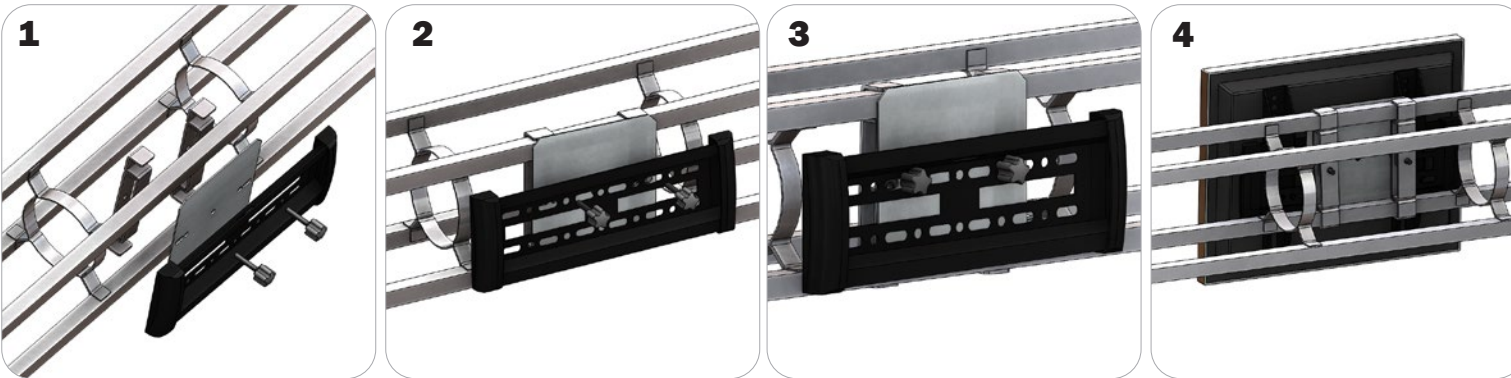

Locate all components needed to assemble the monitor mount with the Horizontal Orbital Truss method. You will need (1) monitor bracket, (2) OR-TVA-PBKT-1 brackets, (2) OR-KNOB-2, and (1) OR-TVA-PLT. Determine your desired monitor location. **Step 1:** Place the OR-TVA-PBKT-1 brackets so that they wrap around the posts of the truss. Add your OR-TVA-PLT and align the holes to the OR-TVA-PBKT-1. **Step 2:** Align your monitor bracket so that the left and right holes align with the plate holes behind them. **Step 3:** One at a time thread your OR-KNOB-2 thumbscrews through the holes. **Step 4:** Reference the included manufacturer monitor mount instructions for fastening your monitor to the bracket.