

# Vector Frame Kit 02

## VF-K-02A



Stand apart from the competition with a clean, sophisticated 10' x 10' or 10' x 20' Vector Frame™ exhibit kit. These graphic mural kits feature square-corner 50mm extrusion frames and push-fit fabric graphics that cover the entire frame. Vector Frame Essential kits are easy to assemble and disassemble.



## features and benefits:

- 50mm silver extrusion frame
- Single-sided fabric graphics
- Easy step-by-step instructions
- Kit includes: one frame, five fabric graphics, three 120 watt floodlights, and one wheeled molded case
- Lifetime hardware warranty against manufacturer defects

## dimensions:

Hardware	Graphic
<p>Assembled unit: 114.65" w x 94.5" h x 16.18" d 2913mm(w) x 2401mm(h) x 411mm(d)</p> <p>Approximate weight: 73 lbs / 34 kg</p>	<p>Refer to related graphic template for more information.</p> <p>Visit: <a href="https://www.theexhibitorshandbook.com/download-graphic-templates">https://www.theexhibitorshandbook.com/download-graphic-templates</a></p>
Shipping	<b>additional information:</b>
<p>Packing case(s): 1 OCE</p> <p>Shipping dimensions: OCE: Expandable case length (l) may vary 40" - 66" l x 18" h x 18" d 1016mm-1677mm(l) x 458mm(h) x 458mm(d)</p> <p>Approximate total shipping weight: 100 lbs / 46 kg</p>	<p>Graphic material: Dye-sublimation SEG push-fit fabric</p> <p>Lights Included: Lumina 200</p>
	<p> This product may include the following materials for recycle: aluminum, select wood, fabric, cardboard, paper, steel, and plastics.</p> <p><b>2 person assembly recommended:</b></p> <p></p>

We are continually improving and modifying our product range and reserve the right to vary the specifications without prior notice. All dimensions and weights quoted are approximate and we accept no responsibility for variance. E&OE. See Graphic Templates for graphic bleed specifications.

\*Not to scale

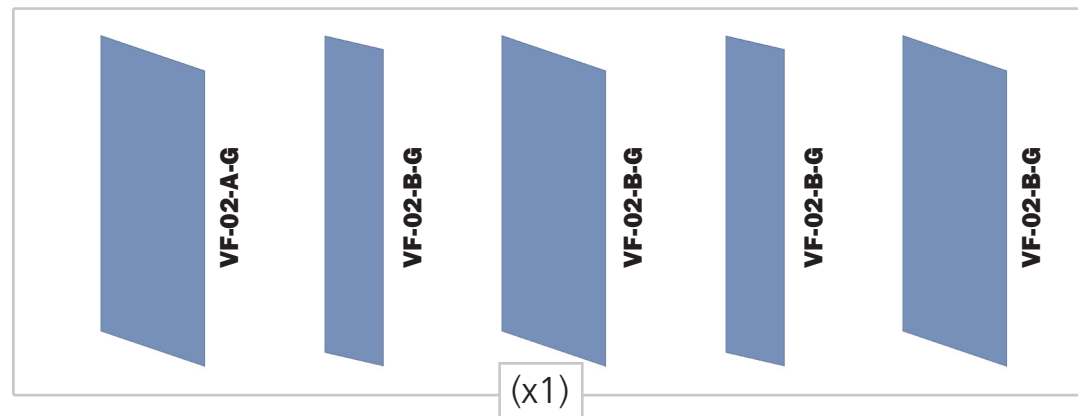
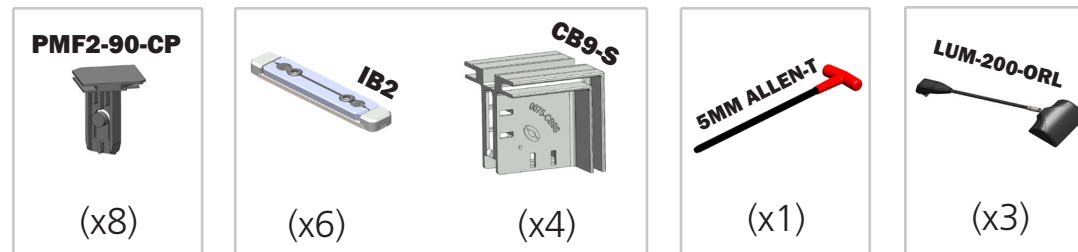
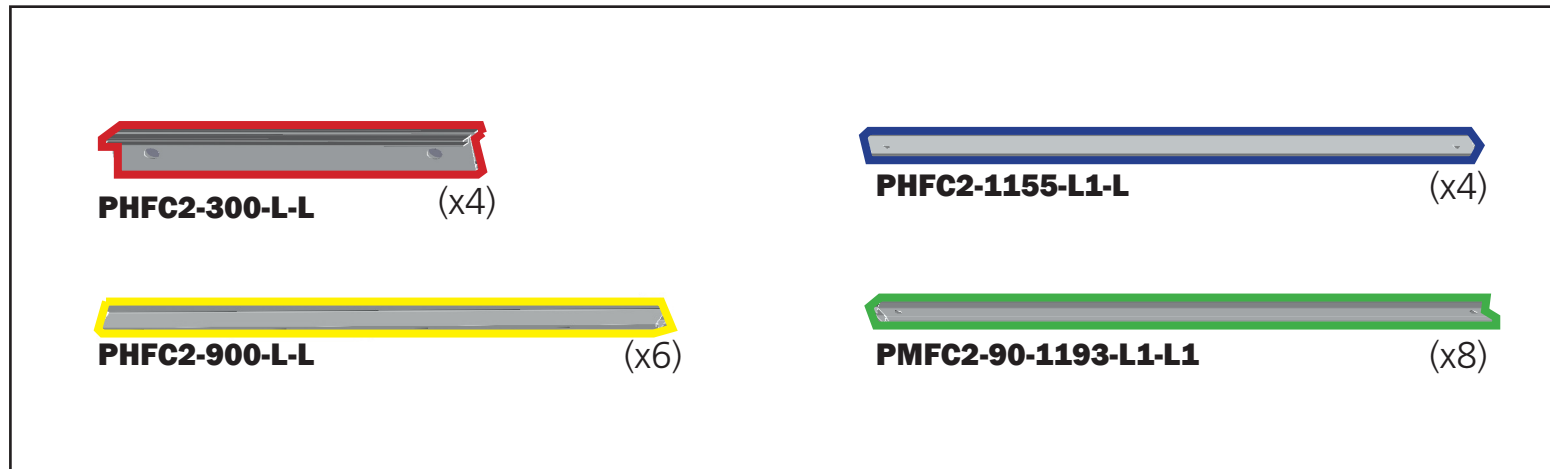

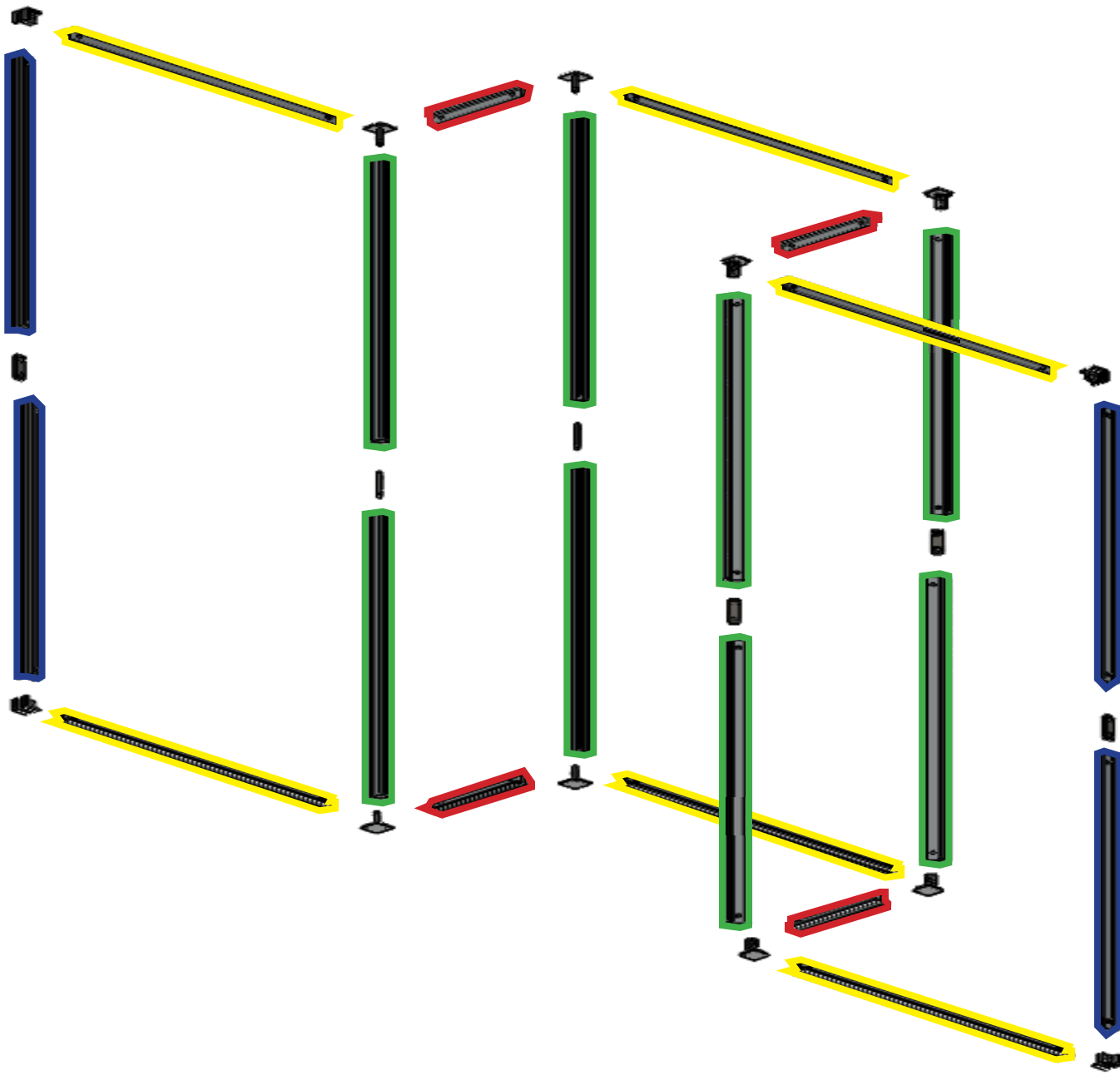

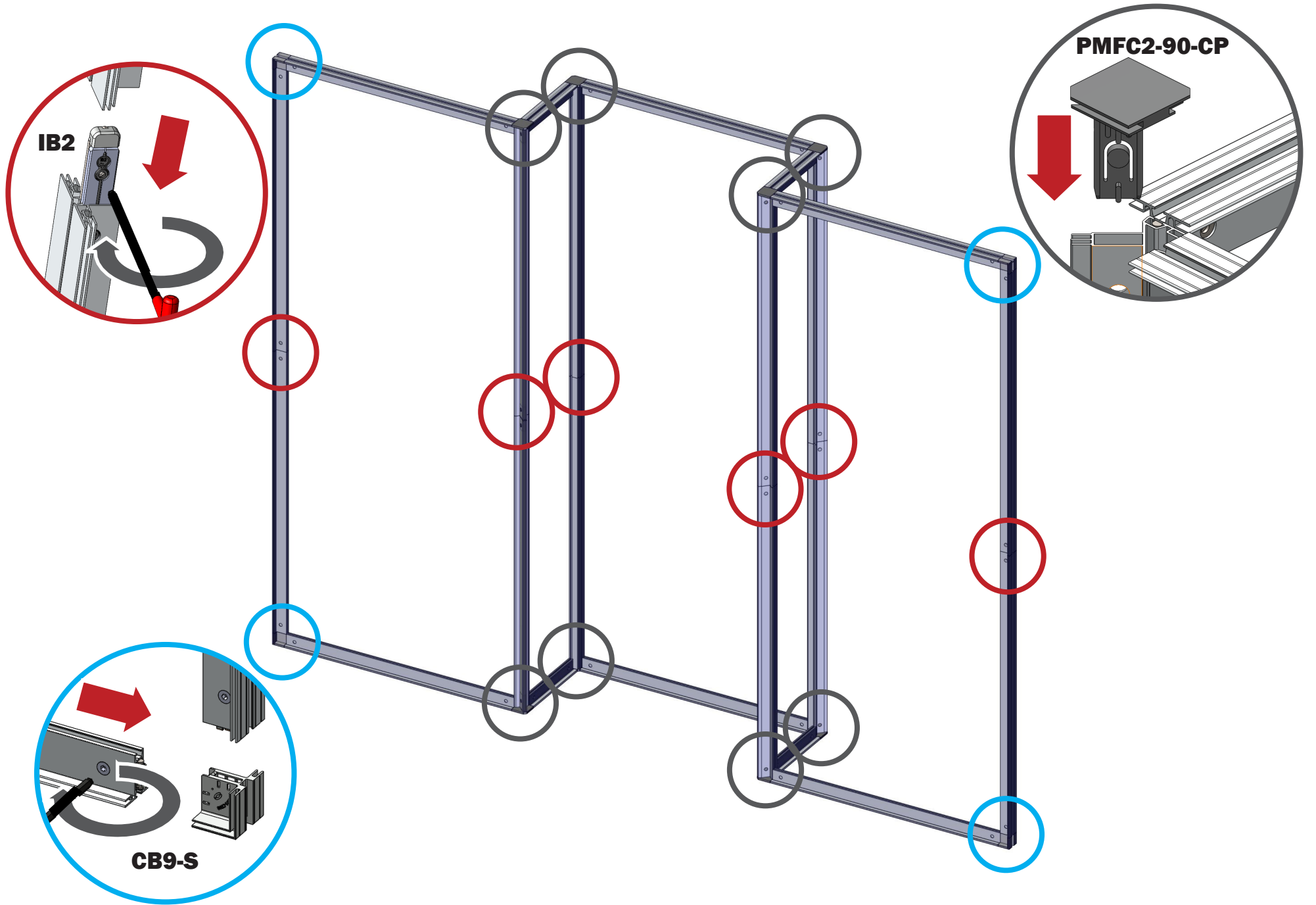

Fit graphic into corners,  
then "tap" into rest  
of frame channel.

"Sliding down" graphic  
is not recommended  
for best installation.

Repeat for backer and for all  
other frames.

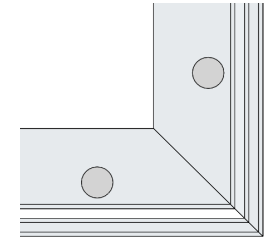
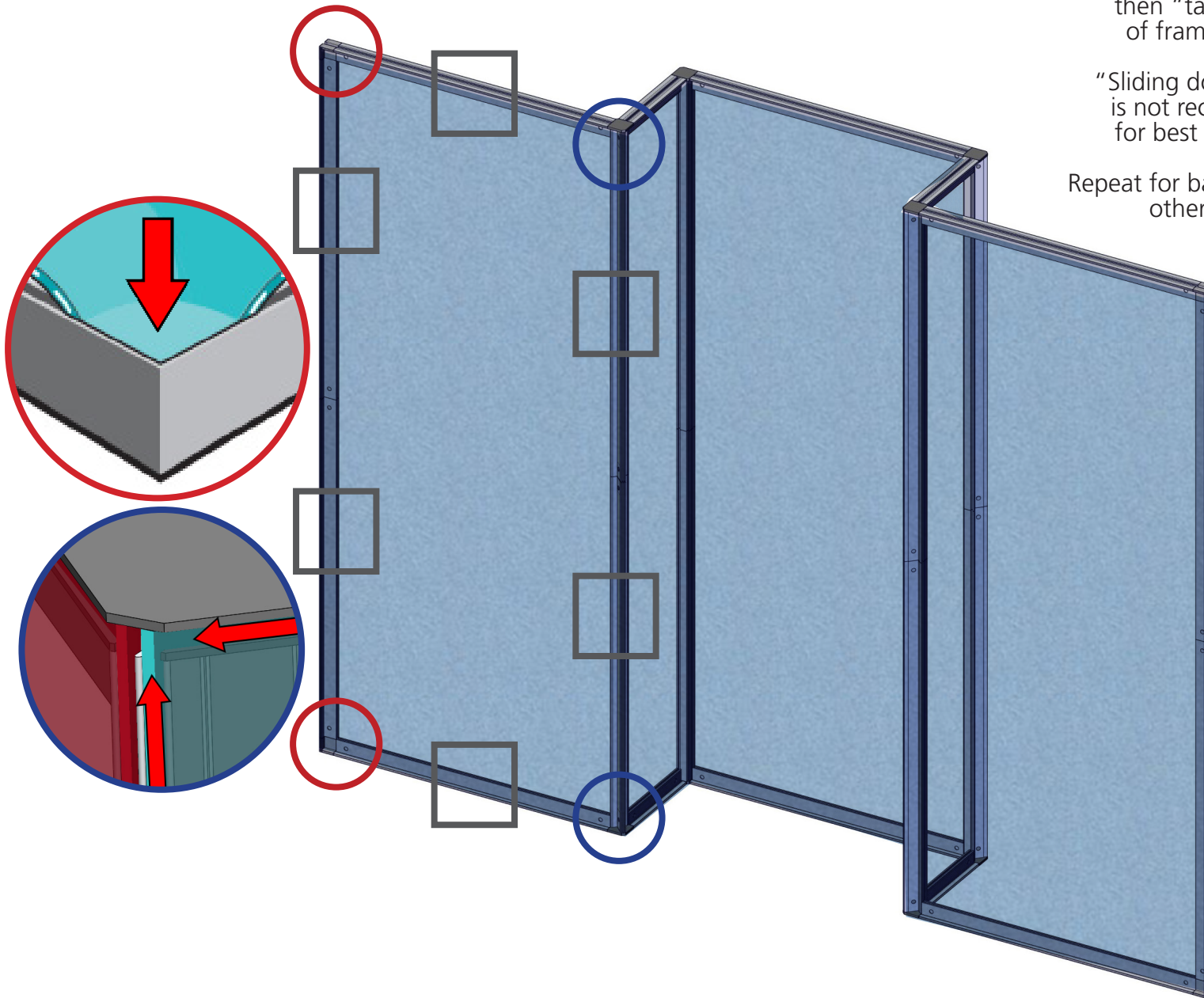

Backer  
2nd channel

Graphic  
1st channel

